

GaAs MMIC FET Transfer Switch DC-4 GHz



AD004T2-00, AD004T2-11

Features

- Broad Bandwidth
- Low DC Power Dissipation (< 20 μ A)
- Low Differential Phase Between Paths
- Meets MIL-STD-883 Screening Requirements
- Chip Size 30 x 39 x 8 Mils

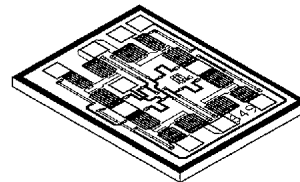

AD004T2-00

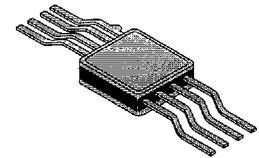

AD004T2-11

Description

The AD004T2-00 is a GaAs 4 Port FET switch configured as a transfer switch. The device is useful for low power transfer switching functions in radar and ECM applications. The AD004T2-11 is the same chip mounted in the 8 Lead Gull Wing flat pack for convenience of surface mounting.

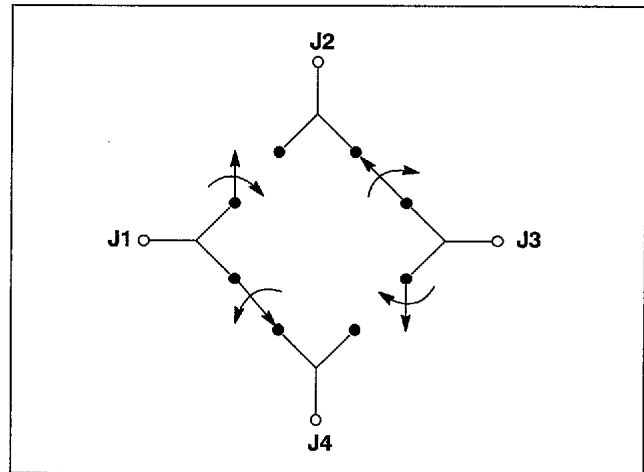

Electrical Specifications at 25 °C

		-00	-11		
Insertion Loss ¹	DC-0.5 GHz	1.0	1.3	dB	Max
	DC-1.0 GHz	1.2	1.5	dB	Max
	DC-2.0 GHz	1.4	1.7	dB	Max
	DC-4.0 GHz	1.6	1.7	dB	Max
Isolation	DC-0.5 GHz	55	47	dB	Min
	DC-1.0 GHz	50	42	dB	Min
	DC-2.0 GHz	45	37	dB	Min
	DC-4.0 GHz	35	30	dB	Min
VSWR I/O	DC-0.5 GHz	1.2:1	1.2:1		Max
	DC-1 GHz	1.3:1	1.4:1		Max
	DC-2 GHz	1.5:1	1.6:1		Max
	DC-4 GHz	1.8:1	2.0:1		Max

1. Insertion Loss changes by 0.003 dB/°C.
 2. Measured in 500 MHz bandwidth with 1 ns risetime pulse.

Operating Characteristics at 25 °C

Impedance	50 Ω Nominal		
Switching Characteristics			
RISE, FALL (10/90% or 90/10% RF)	7	ns	Typ
ON, OFF (50% CTL to 90/10% RF)	14	ns	Typ
Video Feedthru ²	20	mV	Typ
Input Power for 1 dB Compression			
Control Voltages (Vdc)	0/-5	0/-8	
0.5-4 GHz	+24	+30	dBm Typ
0.001 GHz	+16	+20	dBm Typ
Intermodulation Intercept Point for Two-tone Input Power up to +13 dBm			
Intercept Points		IP2	IP3
0.5-4 GHz	+68	+46	dBm Typ
0.001 GHz	+57	+35	dBm Typ
Control Voltages			
V ₀ (Low)	0 to -0.2V @ 20 μ A Max		
V ₀ (High)	-5V @ 50 μ A to -9V @ 200 μ A Max		

Typical Performance Data

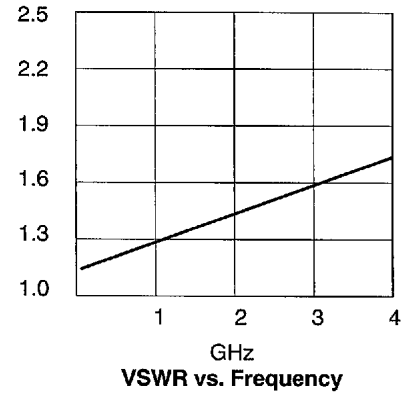
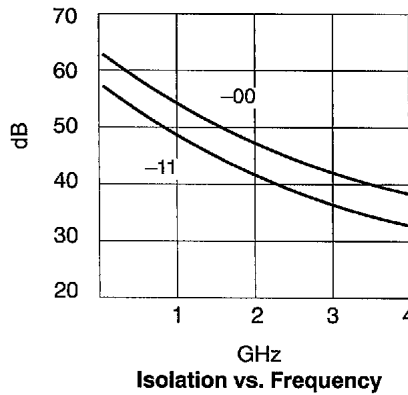
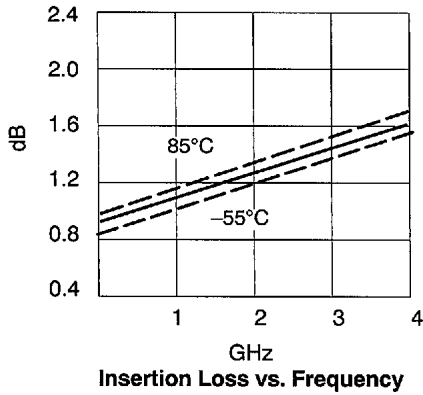

Schematic Diagram

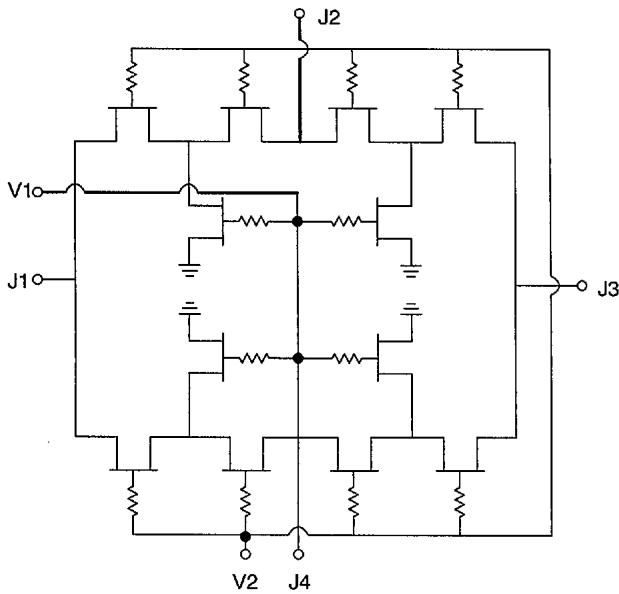

Truth Table

V1	V2	J1-J2	J3-J2	J3-J4	J1-J4
0	-5	Isolation	Insertion Loss	Isolation	Insertion Loss
-5	0	Insertion Loss	Isolation	Insertion Loss	Isolation

Absolute Maximum Ratings

RF Input Power: 2W > 500 MHz 0/-8V
 0.5W @ 50 MHz 0/-8V

Control Voltage: +0.2V, -10V

Operating Temperature: -55°C to 125°C

Storage Temperature: -65°C to 150°C

Thermal Resistance: 25°C/W

Pin Out

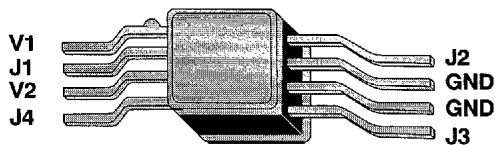

Chip Outline^{1,2}

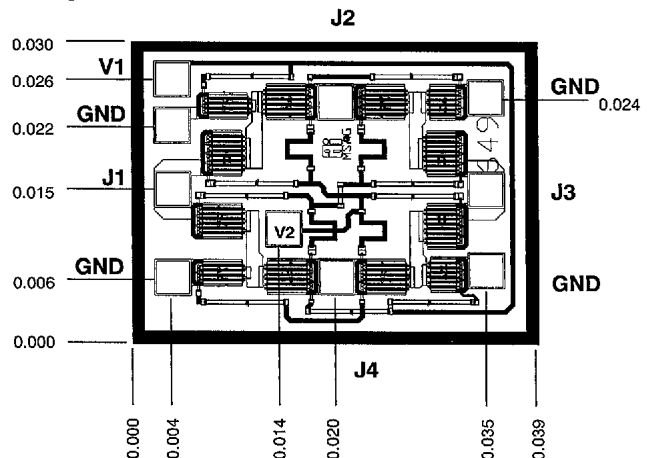

1. Dimensions are in inches. All bond pads are 3.5x3.5 mils.
2. Refer to the Application Notes section for chip handling procedure.